

KEY

ASCOT BASIC

Questo marchio contraddistingue i prodotti nati per rendere più accessibili lo stile, la tecnologia, l'esperienza Ascot. L'ineccepibile qualità tecnica dei materiali accompagna un'estetica che esprime eleganza e buon gusto.

This brand distinguishes the classic lines that afford entry into the wonderful world of Ascot at an accessible price. The impeccable technical quality of the products is accompanied by a visual appeal expressing elegance and good taste.

Cette marque caractérise les lignes d'empreinte classique qui permettent d'entrer dans le monde Ascot à des coûts compétitifs. La qualité technique incomparable des matériaux se marie à une beauté qui exprime élégance et goût.

Die Marke Ascot Basic steht für klassische Produktlinien, die zu wettbewerbsfähigen Preisen den Schritt in die Ascot-Welt ermöglichen. Die makellose technische Qualität der Werkstoffe geht einher mit einer Produktästhetik, die Eleganz und guten Geschmack kombiniert.



KEY

IN

OUT





KEY

BEIGE IN



KEY

RUST OUT









KEY

GREEN OUT
RUST OUT





KEY



GREEN OUT
RUST OUT

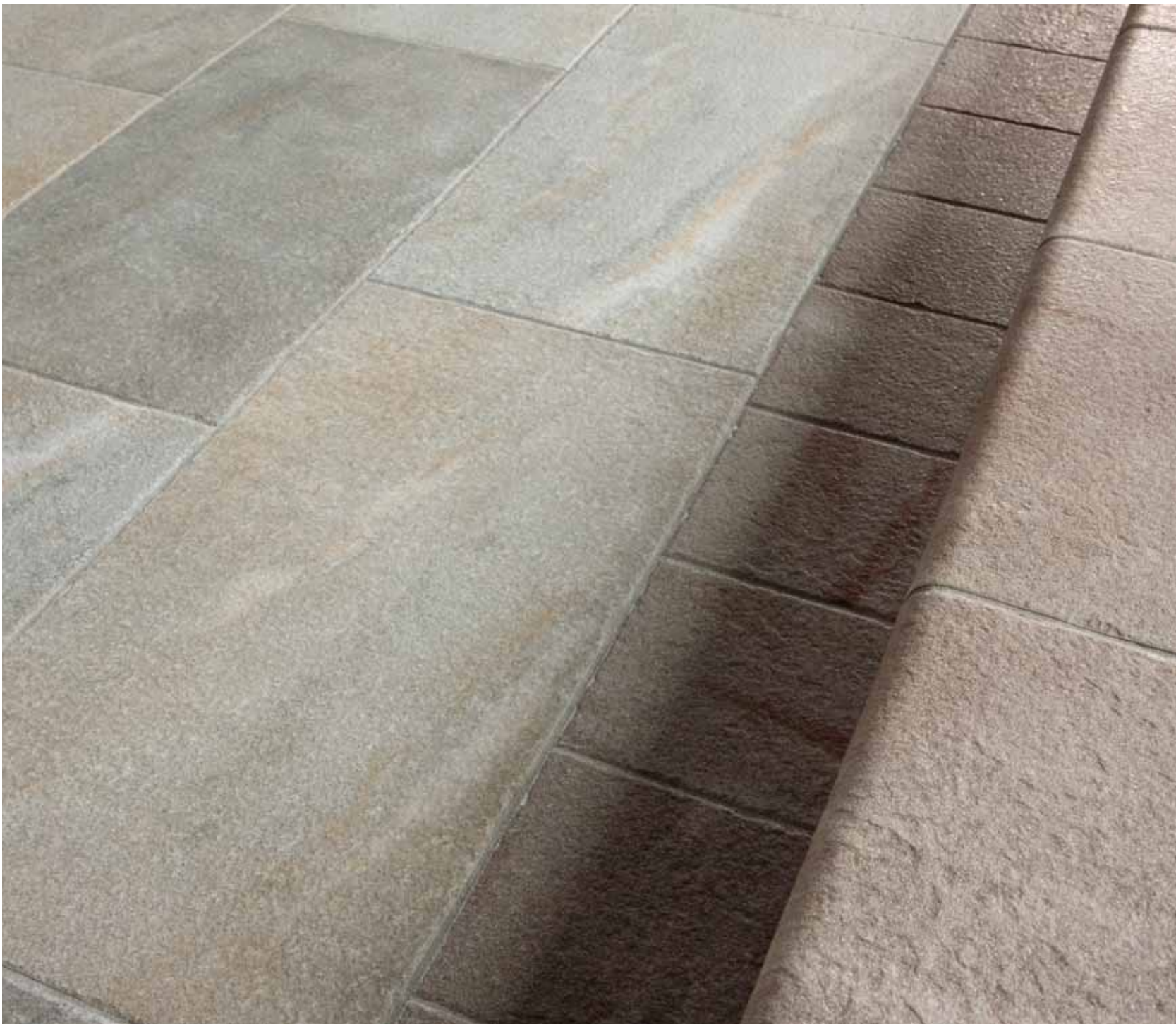

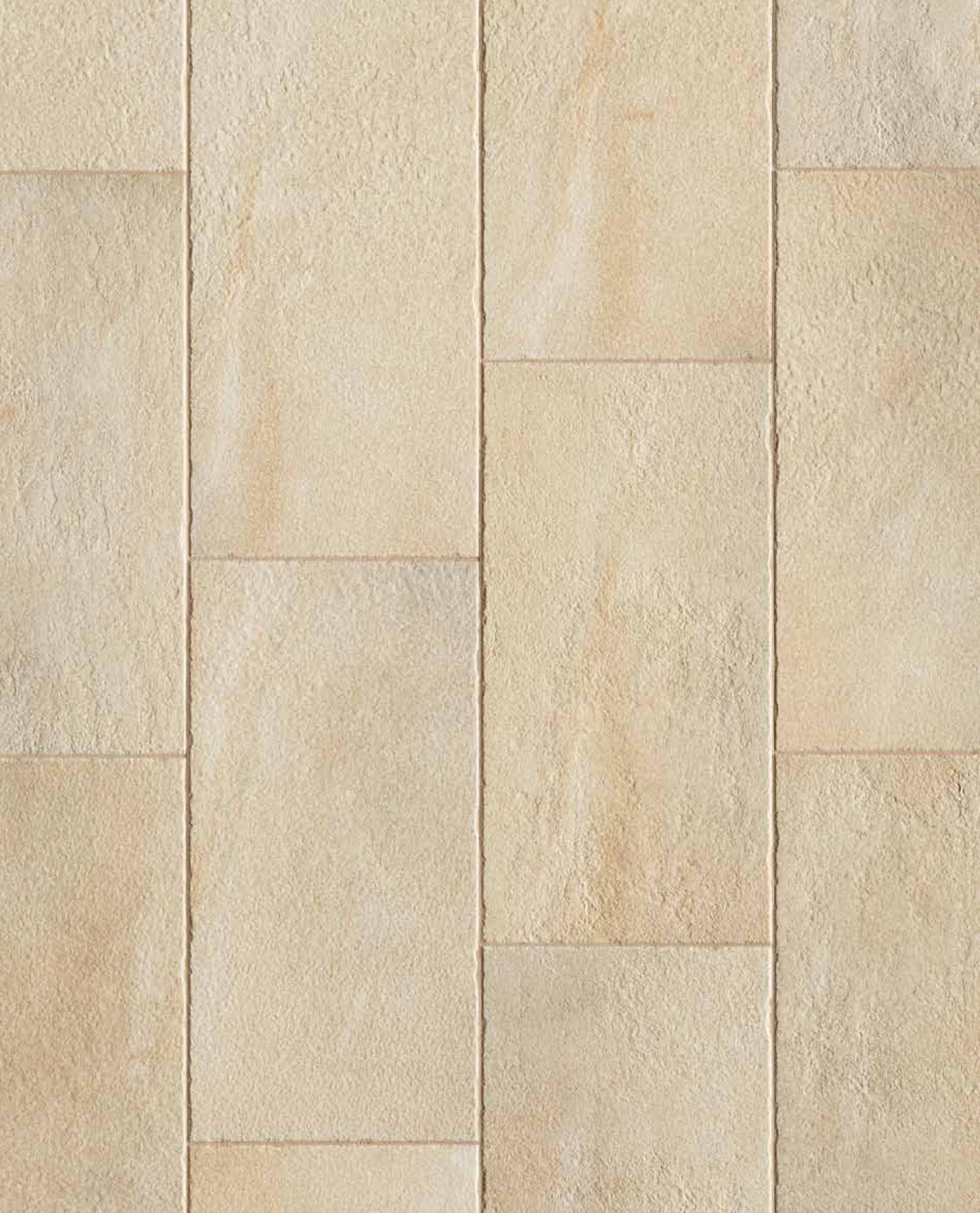



V4

KY020I Key Beige IN 33,3x33,3 13"x13" 581
KY020O Key Beige OUT 33,3x33,3 13"x13" 561



V4

KY620I Key Beige IN 60x60 24"x24" 589
KY620O Key Beige OUT 60x60 24"x24" 568



V4

KY200I Key Beige IN 16,4x16,4 6"x6" 596
KY200O Key Beige OUT 16,4x16,4 6"x6" 576



V4

KY320I Key Beige IN 30x60 12"x24" 593
KY320O Key Beige OUT 30x60 12"x24" 572



KY20IDS Key Beige IN Domino Small 33,3x33,3 13"x13" 576



KY20ID Key Beige IN Domino 33,3x33,3 13"x13" 535





V4

KY0901 Key Green IN 33,3x33,3 13"x13" **581**
KY0900 Key Green OUT 33,3x33,3 13"x13" **561**



V4

KY6901 Key Green IN 60x60 24"x24" **589**
KY6900 Key Green OUT 60x60 24"x24" **568**



V4

KY9001 Key Green IN 16,4x16,4 6"x6" **596**
KY9000 KeyGreen OUT 16,4x16,4 6"x6" **576**



V4

KY3901 Key Green IN 30x60 12"x24" **593**
KY3900 Key Green OUT 30x60 12"x24" **572**



KY90IDS Key Green IN Domino Small 33,3x33,3 13"x13" **576**



KY90ID Key Green IN Domino 33,3x33,3 13"x13" **535**





V4

KY040I Key Rust IN 33,3x33,3 13"x13"
KY040O Key Rust OUT 33,3x33,3 13"x13" 581
561



V4

KY640I Key Rust IN 60x60 24"x24"
KY640O Key Rust OUT 60x60 24"x24" 589
568



V4

KY400I Key Rust IN 16,4x16,4 6"x6"
KY400O Key Rust OUT 16,4x16,4 6"x6" 596
576



V4

KY340I Key Rust IN 30x60 12"x24"
KY340O Key Rust OUT 30x60 12"x24" 593
572



KY40IDS Key Rust IN Domino Small 33,3x33,3 13"x13" 576



KY40ID Key Rust IN Domino 33,3x33,3 13"x13" 535



KY200D Key Beige OUT Pavé 103x65x19 41"x25"x7,5" (mq 0,40)

614



KY900D Key Green OUT Pavé 103x65x19 41"x25"x7,5" (mq 0,40)

614



KY400D Key Rust OUT Pavé 103x65x19 41"x25"x7,5" (mq 0,40)

614

Materiale venduto al mq - Item sold by sqmt
Article vendu au m² - Artikel per qm verkauft

Materiale venduto al pz - Item sold by piece
Article vendu a la piece - Artikel per stueck verkauft

scalino

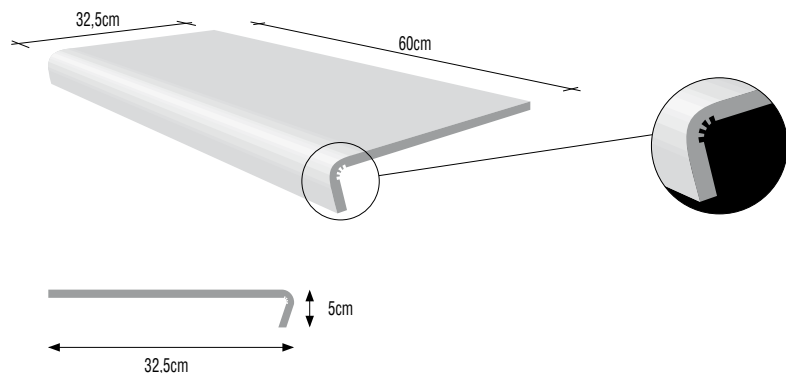

- KY620S** Key Beige OUT Scalino 60x32,5x5 24"x12,8"x2" 595
- KY690S** Key Green OUT Scalino 60x32,5x5 24"x12,8"x2" 595
- KY640S** Key Rust OUT Scalino 60x32,5x5 24"x12,8"x2" 595

angolo scalino

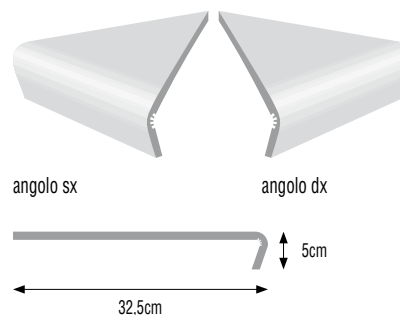

- KY620AS** Key Beige OUT Ang. Scalino 32,5x32,5 12,8"x12,8" 642
- KY690AS** Key Green OUT Ang. Scalino 32,5x32,5 12,8"x12,8" 642
- KY640AS** Key Rust OUT Ang. Scalino 32,5x32,5 12,8"x12,8" 642

terminale

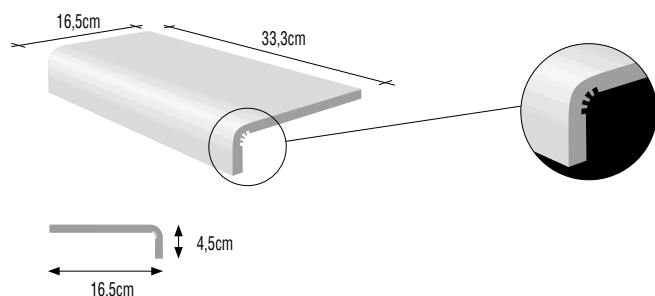

- KY200T** Key Beige OUT Terminale 16,5x33,3x4,5 6,5"x13"x1,7" 531
- KY900T** Key Green OUT Terminale 16,5x33,3x4,5 6,5"x13"x1,7" 531
- KY400T** Key Rust OUT Terminale 16,5x33,3x4,5 6,5"x13"x1,7" 531











- KY200B** Key Beige OUT Battiscopa 8x33,3 3 1/8"x13" 507
- KY900B** Key Green OUT Battiscopa 8x33,3 3 1/8"x13" 507
- KY400B** Key Rust OUT Battiscopa 8x33,3 3 1/8"x13" 507



- KY621B** Key Beige IN Battiscopa 9x60 3,5"x24" 510
- KY620B** Key Beige OUT Battiscopa 9x60 3,5"x24" 508
- KY691B** Key Green IN Battiscopa 9x60 3,5"x24" 510
- KY690B** Key Green OUT Battiscopa 9x60 3,5"x24" 508
- KY641B** Key Rust IN Battiscopa 9x60 3,5"x24" 510
- KY640B** Key Rust OUT Battiscopa 9x60 3,5"x24" 508

Dati tecnici secondo norme:
Technical data conform to:
Caractéristiques techniques d'après normes:
Technische Daten nach den Normen:
EN 14411 B I, GL

Caratteristiche tecniche Technical data Caractéristiques techniques Technische Daten	Norme Normes Normes Norm	Valori ascot Value ascot Valeur ascot Wert ascot	Caratteristiche tecniche Technical data Caractéristiques techniques Technische Daten	Norme Normes Normes Norm	Valori ascot Value ascot Valeur ascot Wert ascot
 Resistenza all'abrasione Abrasion resistance Résistance à l'abrasion Abrasionswiderstandigkeit	ISO 10545-7	PEI V	 Resistenza all'attacco acido e basico Glaze resistance to acid and alkaline attack Résistance aux acides et aux bases Säure- und laugenfestigkeit	ISO 10545-13	Resiste Resists Resiste Bestanding
 Assorbimento d'acqua Water absorption Absorption d'eau Wasseraufnahme	ISO 10545-3	≤ 0,4 %	 Resistenza alle macchie Stain resistance Résistance aux taches Fleckenfestigkeit	ISO 10545-14	Totale Complete Totale Absolut
 Resistenza alla flessione Breaking modulus Résistance à la flexion Biegefestigkeit	ISO 10545-4	40-55 N/mm²	 Resistenza al gelo Resistance to frost Résistance au gel Frostbeständigkeit	ISO 10545-12	Non gelive Frost proof Ingeleit Frostsicher
 Durezza Mohs Mohs hardness Dureté Mohs Haerte Mohs	UNI 101	7	 Scivolosità Slipperiness Degré de glissement Rutschhemmung	DIN 51130	R10
ASTM Scivolosità Slipperiness Degré de glissement Rutschhemmung	ASTM C1028	WET > 0,83 DRY > 0,66	 Scivolosità Slipperiness Degré de glissement Rutschhemmung	DIN 51097	C

GRADO DI STONALIZZAZIONE
Amount of colour variation
Degré de dénuancement
Tonabweichungsstufe

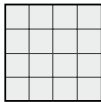
 **V1**
BASSA STONALIZZAZIONE
Low colour variation
Faible dénuancement
Geringe Tonabweichung

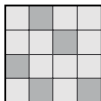
 **V2**
MEDIA STONALIZZAZIONE
Medium colour variation
Dénuancement moyen
Mittlere Tonabweichung

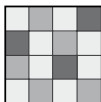
 **V3**
ALTA STONALIZZAZIONE
High colour variation
Haut dénuancement
Starke Tonabweichung

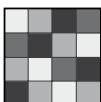
 **V4**
MASSIMA STONALIZZAZIONE
Maximum colour variation
Dénuancement maximum
Stärkste Tonabweichung

IMBALLI - PACKING - VERPACKUNG - EMBALLAGE - EMBALAJE

FORMATO	MQ./SCATOLA	PEZZI/SCATOLA	KG./SCATOLA	SCATOLE/PALLET	MQ./PALLET	KG./PALLET	SPESSORE
SIZE	SQM./BOX	PIECES/BOX	KG./BOX	BOXES/PALLET	SQM./PALLET	KG./PALLET	THICKNESS
FORMAT	QM./KARTON	STÜCK/KARTON	KG./KARTON	KARTONS/PALETTE	QM./PALETTE	KG./PALETTE	STÄRKE
FORMAT	M ² /BOÎTE	PIECES/BOÎTE	KG./BOÎTE	BOÎTE/PALETTE	M ² /PALETTE	KG./PALETTE	EPAISSEURS
FORMATO	MQ./CAJA	PIEZAS/CAJA	KG./CAJA	CAJA/PALLET	MQ./PALLET	KG./PALLET	ESPEJOR
60x60 fondo	1,440	4	32,11	30	43,20	978	10 mm
33,3x33,3 fondo	1,332	12	25,50	42	55,94	1.086	10 mm
16,4x16,4 fondo	1,183	44	23,20	55	65,07	1.291	10 mm
30x60 fondo	1,080	6	26,14	40	43,20	1.061	10 mm
103x65x19 Pavé	-	2	-	-	-	-	
60x32,5x5 scalino	-	4	-	-	-	-	
32,5x32,5 ang. scal.	-	2	-	-	-	-	
16,5x33,3x4,5 terminale	-	8	-	-	-	-	
9x60 battiscopa	-	12	-	-	-	-	
8x33,3 battiscopa	-	12	-	-	-	-	





C E R A M I C H E

CERAMICHE ASCOT S.P.A.
VIA CROCE, 80
41014 SOLIGNANO (MO) ITALY
TEL +39 059 77.84.11
FAX +39 059 77.84.44/43
i n f o @ a s c o t . i t
w w w . a s c o t . i t



Ceramic Tiles of Italy